



Blow Moulding Technologies

Blowmoulding

Thermoforming



Injection Moulding

Rotational moulding



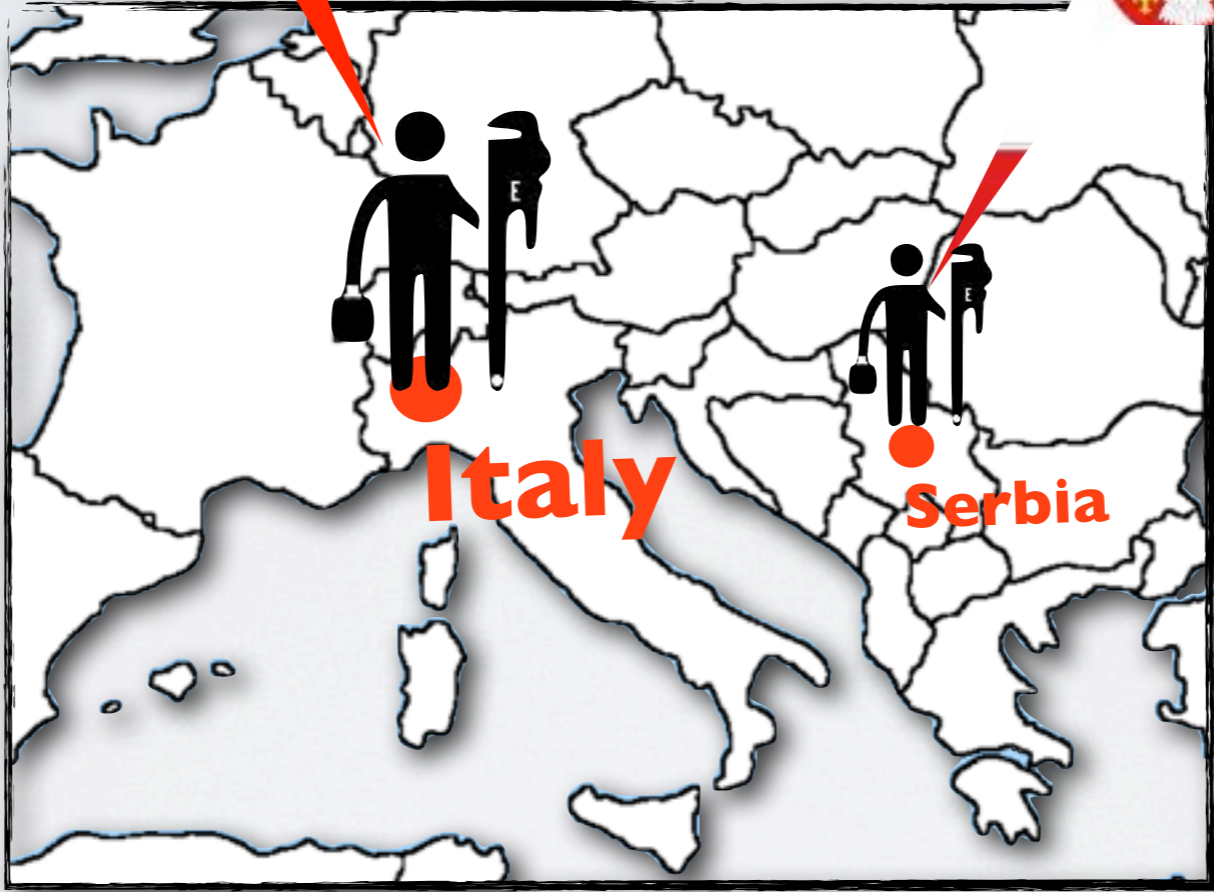



Elmeg Italy

Turnover (Mio €)

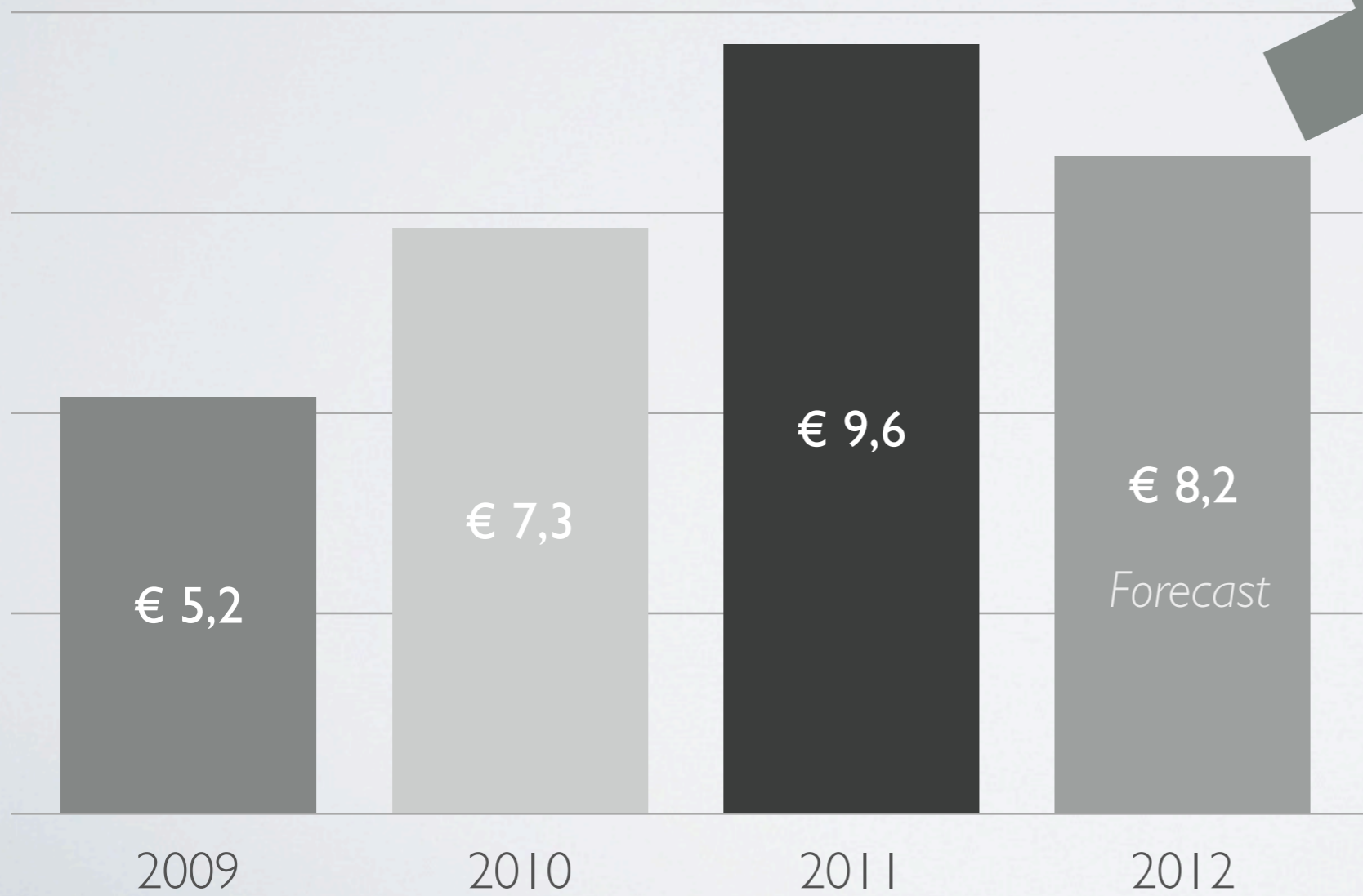

Appliances
15%

Other
10%

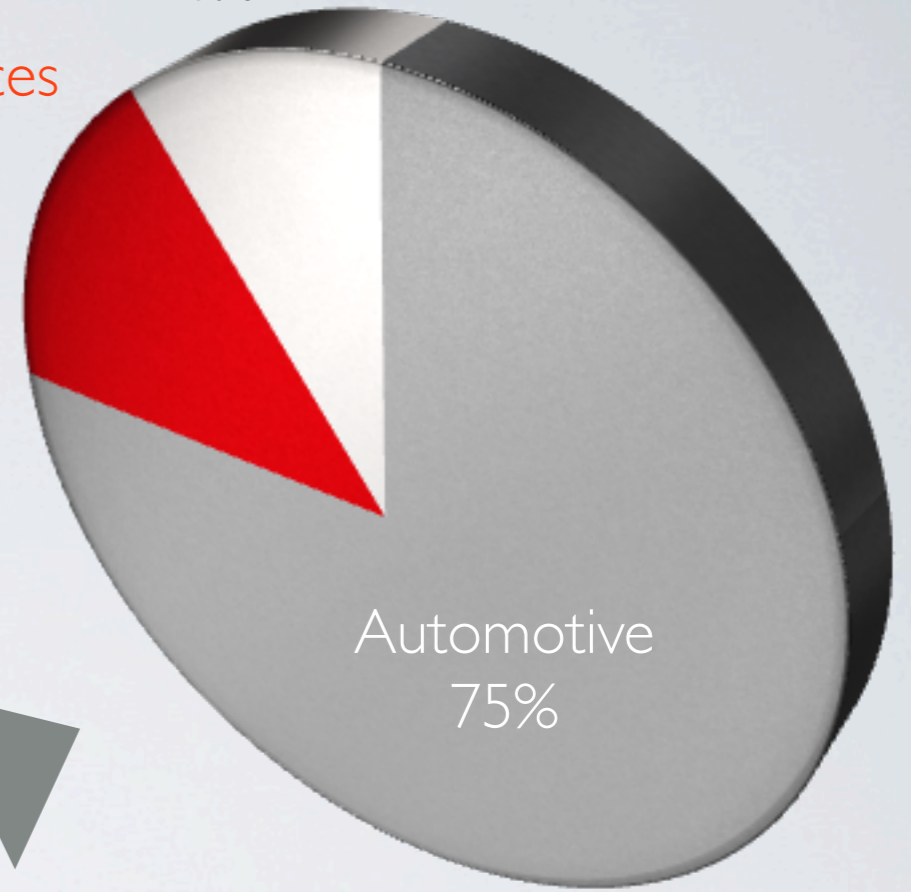

Automotive
75%

CERTIFICATIONS

• ISO TS 16949



• ISO 14001



SGS - SGS

SGS

Certificate IATF 0113134
Certificate SGS IT10/0984

The management system of
Elmeg. S.r.l.
s.s. Asti - Alba, 7
14057 Isola d'Asti (AT), Italy

Has been assessed and certified as meeting the requirements of
ISO/TS 16949:2009
Edition 3



Certificato N. IT11/0164

Il sistema di gestione ambientale di
ELMEG S.r.l.
S.S. Asti - Alba, 7 - 14057 ISOLA D'ASTI (AT) - Italia

è stato verificato ed è risultato conforme ai requisiti di
ISO 14001 / UNI EN ISO 14001:2004

Scopo della certificazione:
Fabbricazione di serbatoi per liquidi, vani accessori e condotti di aria mediante soffiaggio di materie plastiche per il settore automotive.
Settori EA: 14

Questo certificato è valido dal 18/02/2011 fino al 18/02/2014.
La validità è subordinata all'esito soddisfacente dell'attività di sorveglianza periodica.
Ricerificazione da eseguirsi entro il 18/02/2014.
Rev. 1. Certificata dal 18/02/2005.

Certificazione rilasciata in conformità al regolamento Tecnico ACCREDIA RT-09

Autorizzato da
Stefano Bertoni

SGS ITALIA S.p.A. - Systems & Services Certification
Via G. Gozzi, 1/A - 20129 MILANO - Italy
t +39 02 73 93 1 f +39 02 70 10 94 89 www.sgs.com

Pagina 1 di 1









the following activities
and air ducts by ing processes.
product Design
November 2013
veillance audits
November 2010
November 2013
November 2010

Authorised by
Lina

ato Power Authority
att Street, Bridgend
Fax 01656 647637.
Neil.Hall@sgs.com

SGS TS-9 0709
Page 1 of 1

1 GP3530

http://www.sgs.com

MACHINES

- 12 Blowmoulding machines (from 7 lt. to 250 lt.)
- 3 Injection moulding machines (from 50 ton. to 250 ton.)
- 1 Rotational moulding machine - Leonardo (Persico)
- 1 Thermoforming machine



TOOLING DESIGN

We design and build our toolings internally.
Elmeg Italy have its own toolshop.



SOFTWARE CAD

-

CATIA



-

UNIGRAPHICS



SOME EXAMPLES OF OUR
PRODUCTION

Fuel tanks

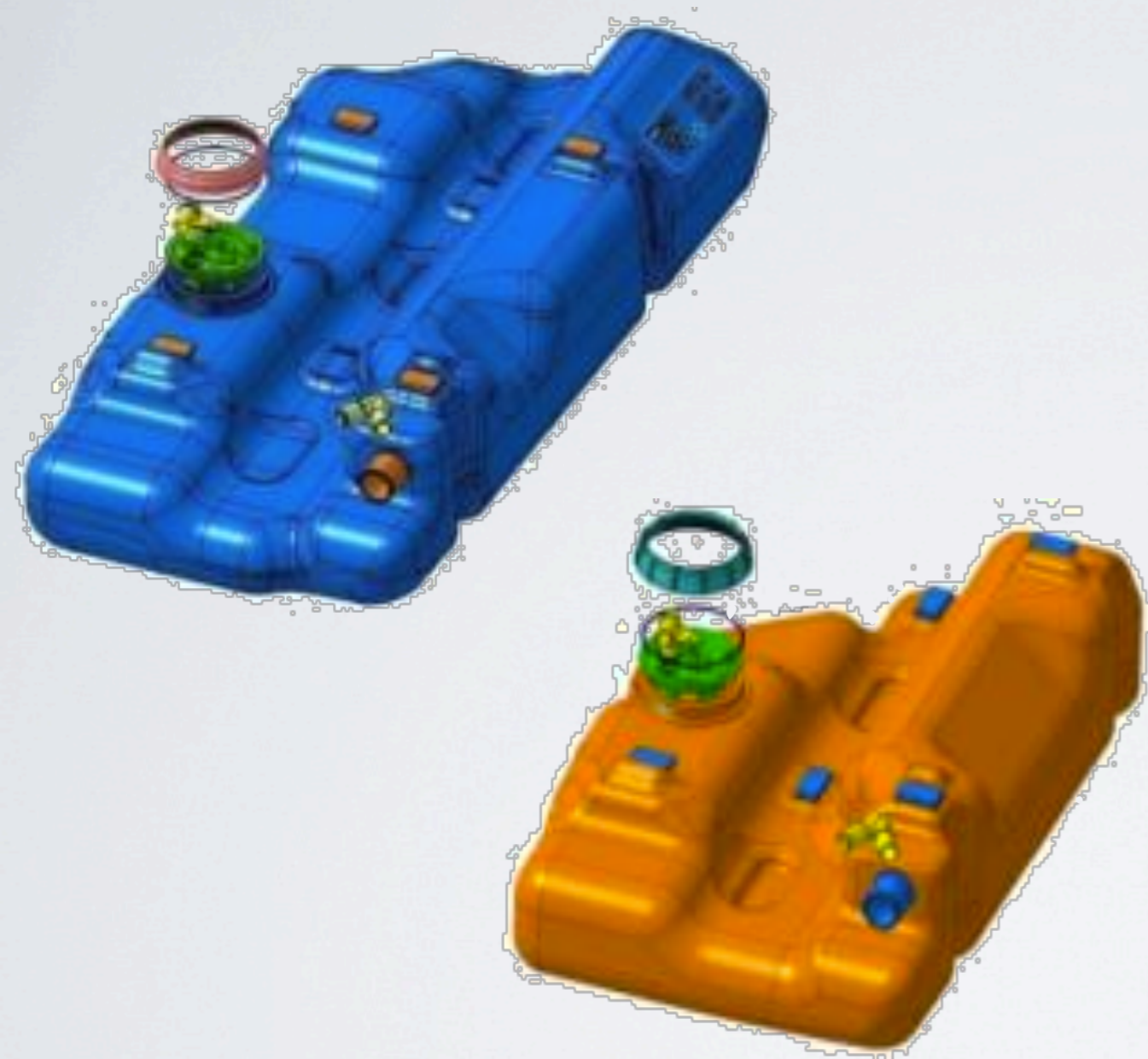

(100 litres and 70 litres)

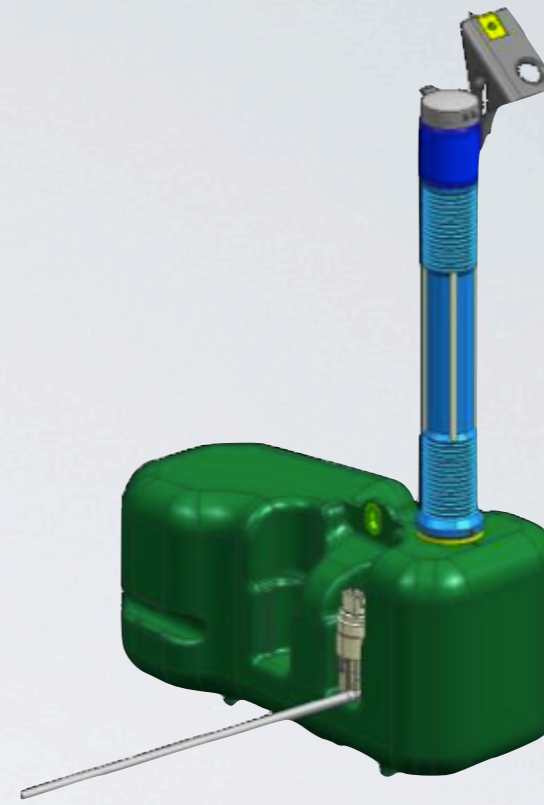

Commercial vehicles windshield washer tanks

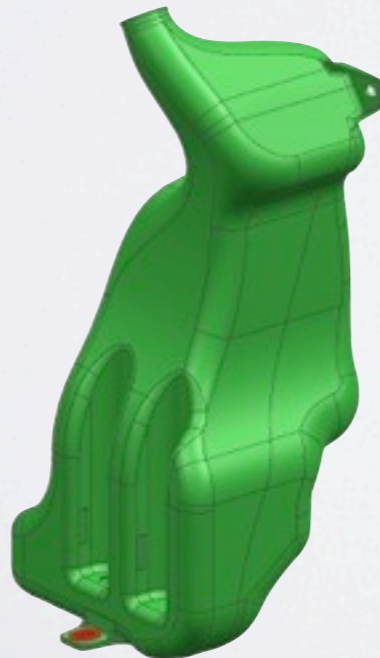

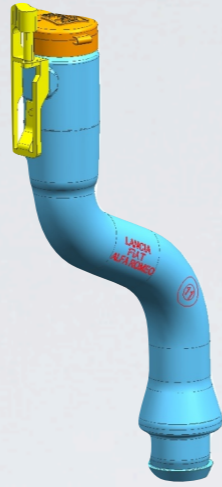
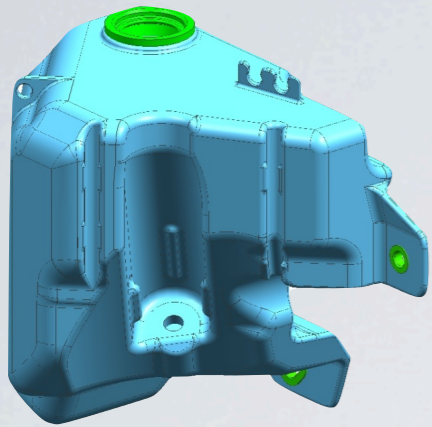

Cars windshield
and headlamps
cleaning tanks

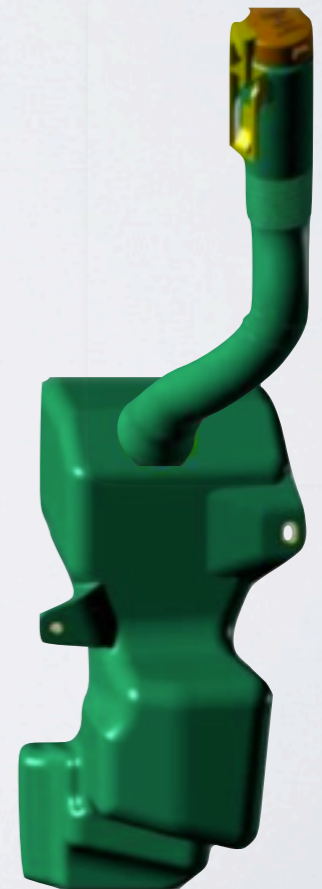
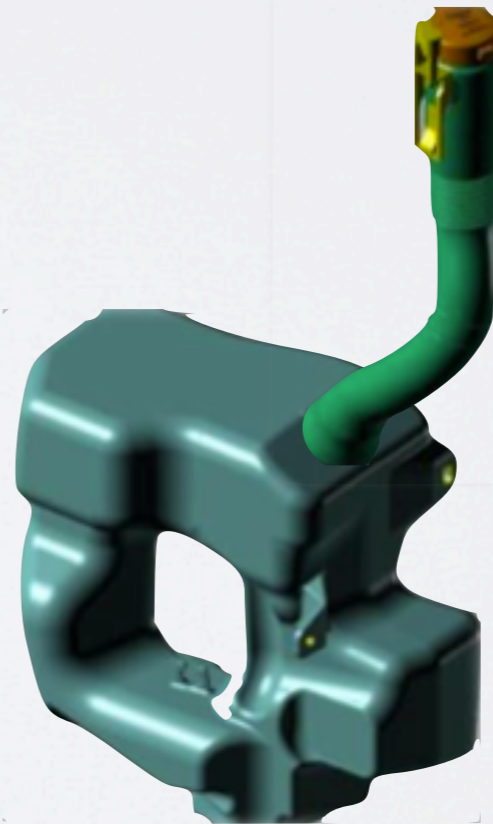

Turbo engines intake duct

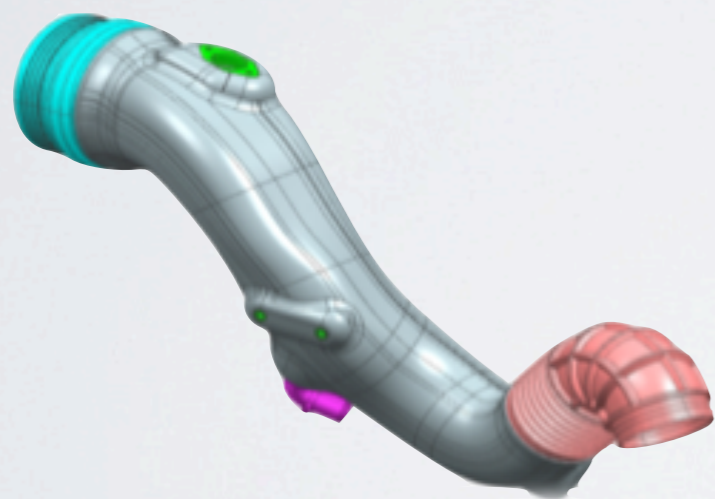
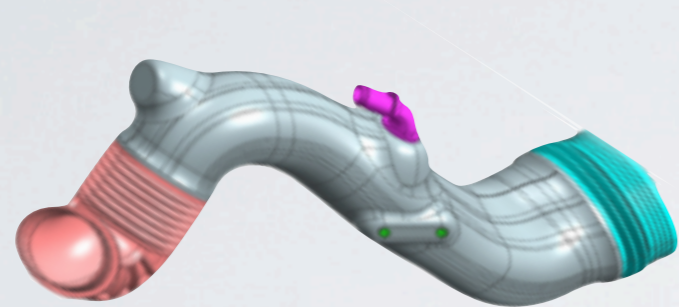

Air ducts



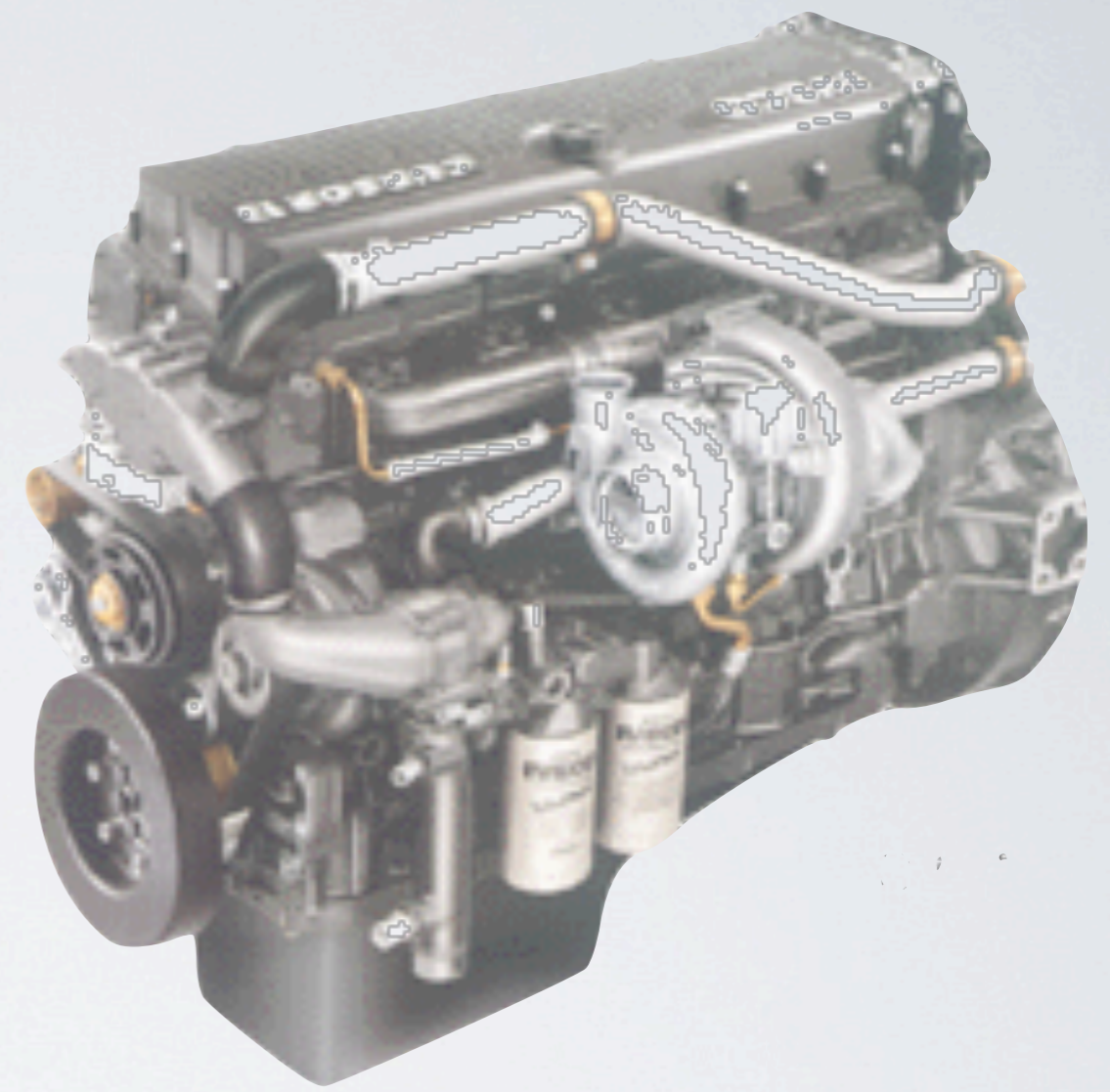
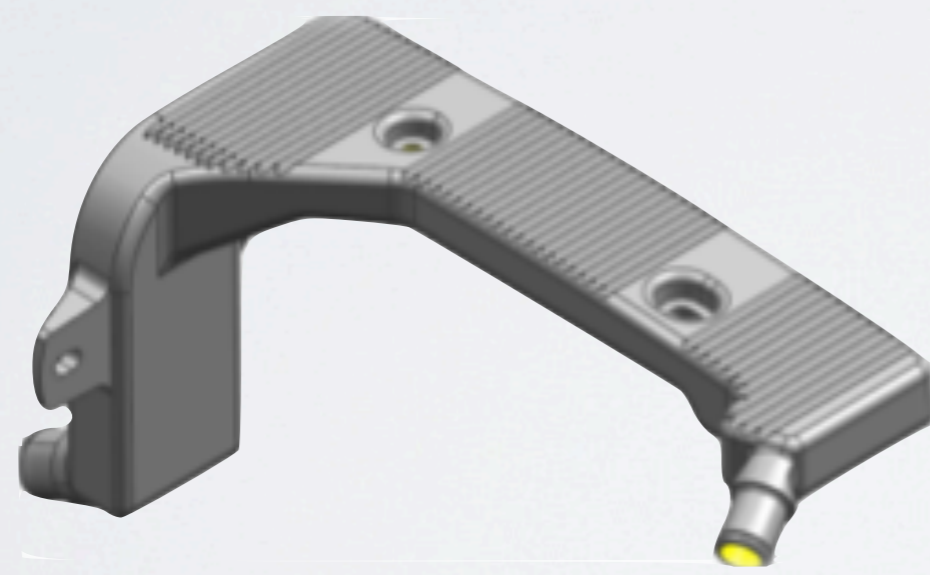
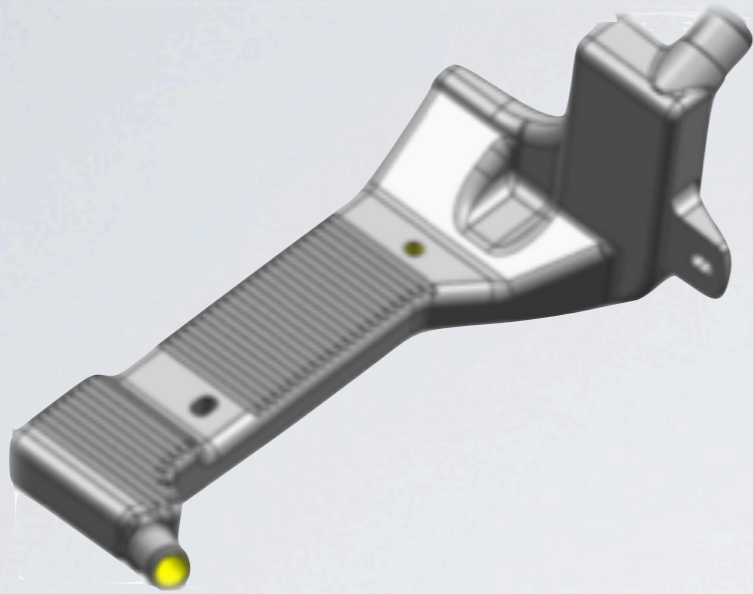

Engine silencer

Autobuses Oil tanks





FRAME/HANDLE
FOR HIGH
PRESSURE WATERJET
CLEANERS

VACUUM CLEANERS TANK





FRAME AND FUEL TANKS FOR HEATING
SYSTEMS



Toys parts



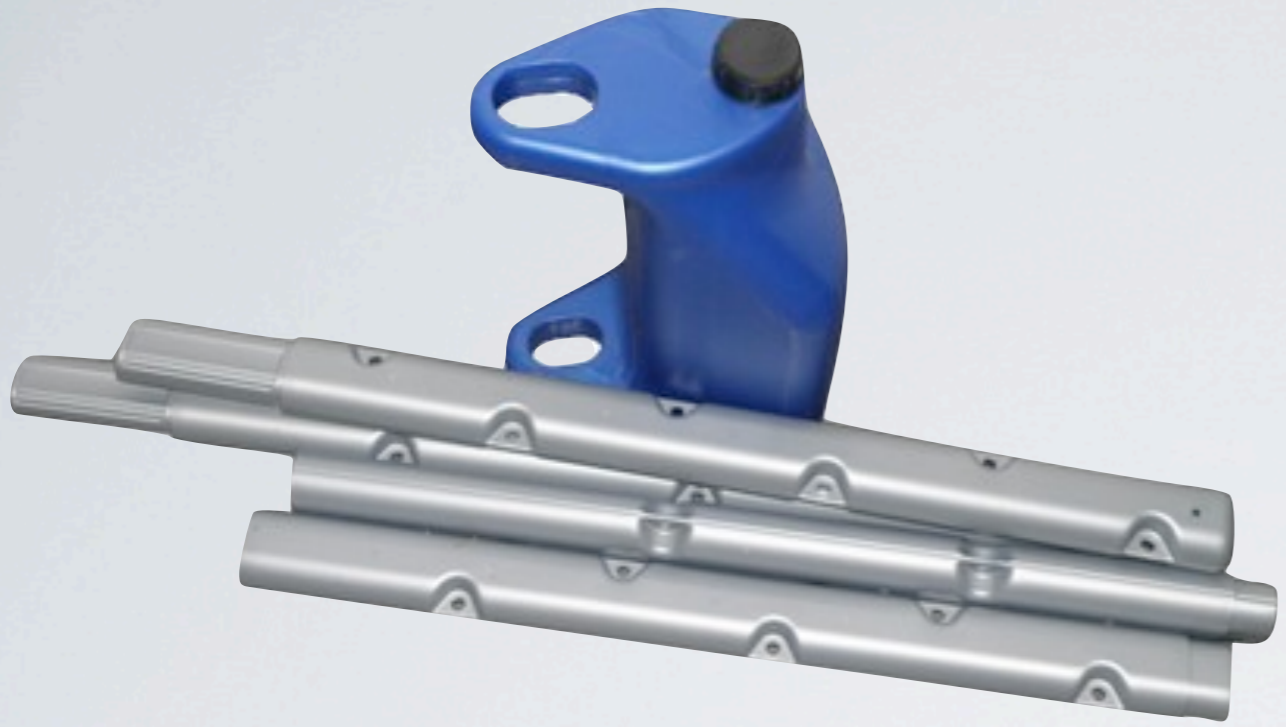

Minivolley camps
components

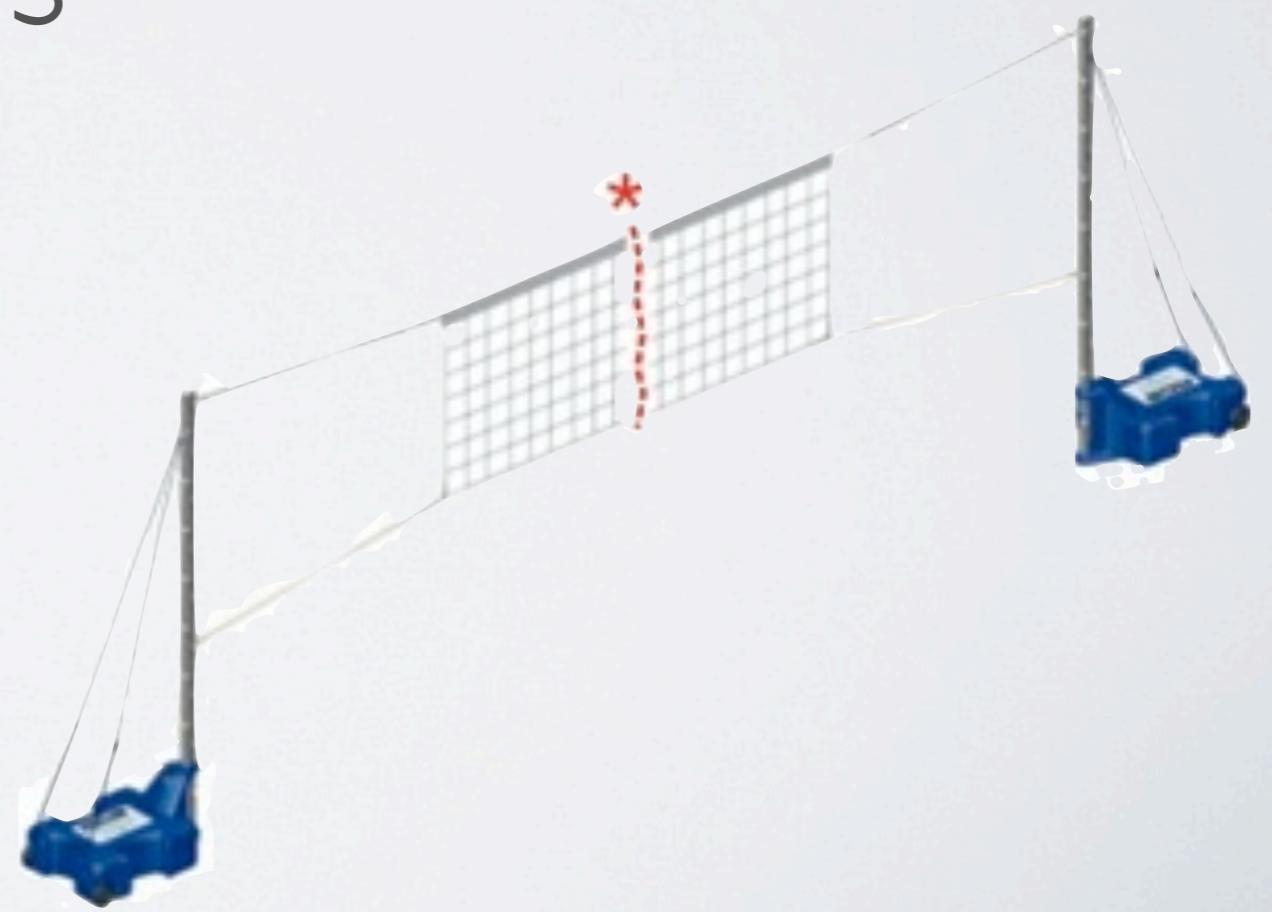



Outdoor furniture





Blow Moulding Technologies

Elmeg S.r.l

S.s 231 Asti-Alba,7

14057 Isola d'Asti

Italy

 +39.0141.96.00.46

 gianluca.giordano@elmeg.it